

1.INTRODUCTION

Lasers have been considered for space communications since their realization in 1960. Specific advancements were needed in component performance and system engineering particularly for space qualified hardware. Advances in system architecture, data formatting and component technology over the past three decades have made laser communications in space not only viable but also an attractive approach into inter satellite link applications.

Information transfer is driving the requirements to higher data rates, laser cross -link technology explosions, global development activity, increased hardware, and design maturity. Most important in space laser communications has been the development of a reliable, high power, single mode laser diode as a directly modulable laser source. This technology advance offers the space laser communication system designer the flexibility to design very lightweight, high bandwidth, low-cost communication payloads for satellites whose launch costs are a very strong function of launch weigh. This feature substantially reduces blockage of fields of view of most desirable areas on satellites. The smaller antennas with diameter typically less than 30 centimeters create less momentum disturbance to any sensitive satellite sensors. Fewer on board consumables are required over the long lifetime because there are fewer disturbances to the satellite compared with heavier and larger RF systems. The narrow beam divergence affords interference free and secure operation.

2.BACKGROUND

Until recently, the United States government was funding the development of an operational space laser cross-link system employing solid-state laser technology. The NASA is developing technology and studying the applicability of space laser communication to NASA's tracking and data relay network both as cross-link and for user relay links. NASA's Jet Propulsion Laboratory is studying the development of large space and ground-base receiving stations and payload designs for optical data transfer from interplanetary spacecraft. Space laser communication is beginning to be accepted as a viable and reliable means of transferring data between satellites. Presently, ongoing hardware development efforts include ESA's Space satellite Link Experiment (SILEX) and the Japanese's Laser Communication Experiment (LCE). The United States development programs ended with the termination of both the production of the laser cross-link subsystem and the FEWS satellite program.

3. SATELLITE FREQUENCY BANDS

The electromagnetic frequency spectrum is as shown below.

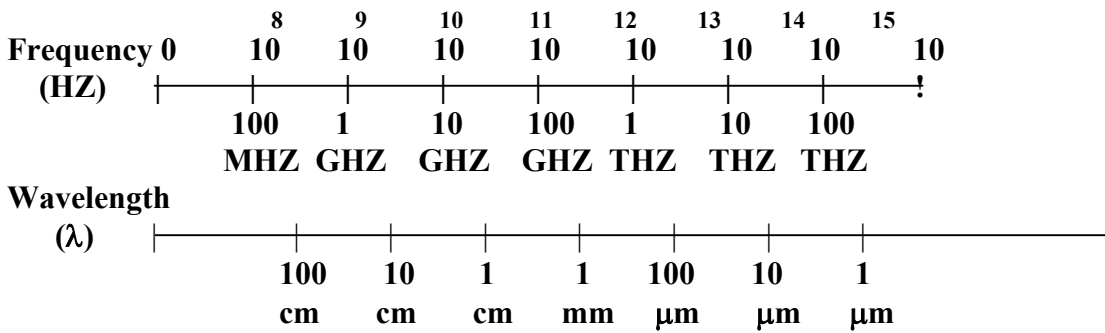
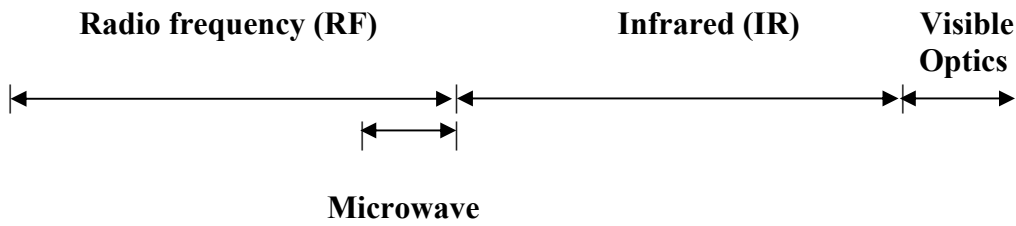

Bands	Frequency
VHF	54 - 216 MHz
UHF	470 - 890 MHz
L	.39 - 1.55 GHz
S	1.55 - 5.2 GHz
C	3.9 - 6.2 GHz
X	5.2 - 10.9 GHz
K	10.9 - 36 GHz
Ku	11.7 - 14.5 GHz
Ka	17 - 31 GHz
Q	36 - 46 GHz
V	46 - 56 GHz

The frequency used for satellite communication should be selected from bands that are most favorable in terms of power efficiencies, minimal propagation of distortion, and reduced noise and interference effects. Terrestrial systems tend to favor these same bands. So, concern for interference effect between the satellite and terrestrial systems must be made.

Satellite use from space must be regulated and shared on a worldwide basis. For this reason, frequencies to be used by the satellite are established by a world body known as the International Telecommunications Union (ITU) with broadcast regulations controlled by a subgroup known as World Administrative Radio Conference (WARC). An international consultative technical committee (CCIR) provides specific recommendations on satellite frequencies under consideration by WARC. The basic objective is to allocate particular frequency bands for different types of satellite services, and also to provide international regulations in the areas of maximum radiation's level from space, co-ordination with terrestrial systems and the use of specific satellite locations in a given orbit. Within these allotments and regulations an individual country can make its own specific frequency selections based on intended uses and desired satellite services.

The frequency bands allocated by WARC (1979) for satellite communication is given below.

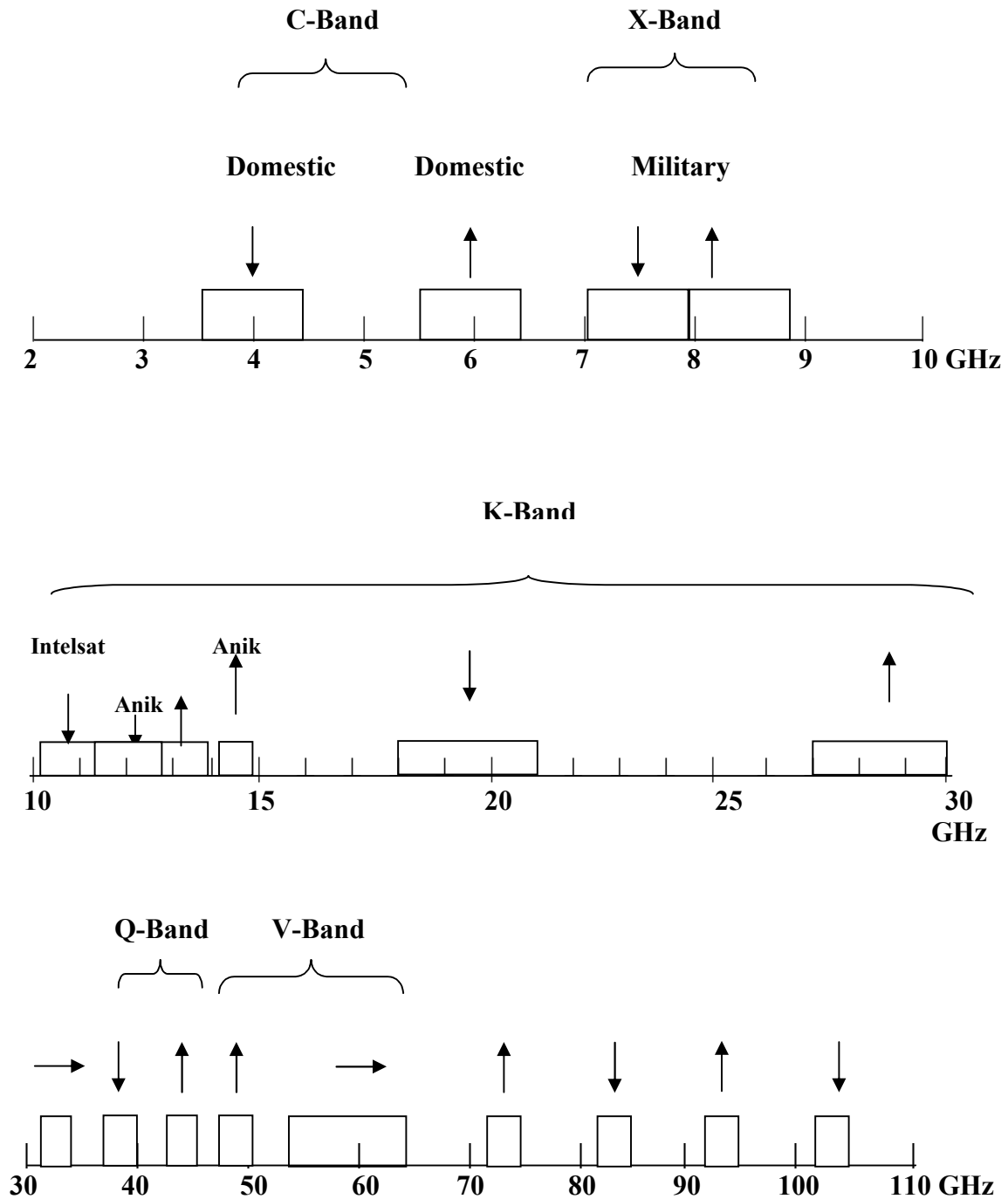

Allocated satellite frequency bands, WARC 1979

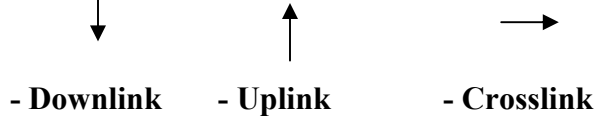

Use of frequencies has been separated into military, non-military, and services has been designated as fixed point (between ground stations located at fixed points on earth), Broadcast (wide area coverage), and mobile (aircraft, ships, land vehicles). Inter satellite refers to satellite cross- links. Most of the early satellite was developed for UHF, C-band and X-band, which required the minimal conversion from existing microwave hardware. The foremost problem is the fact that the available bandwidth in these bands will be inadequate to meet present and future traffic demands. The advantage of using a carrier at higher frequencies is the ability to modulate more information on it.

4. LASER COMMUNICATION SYSTEM

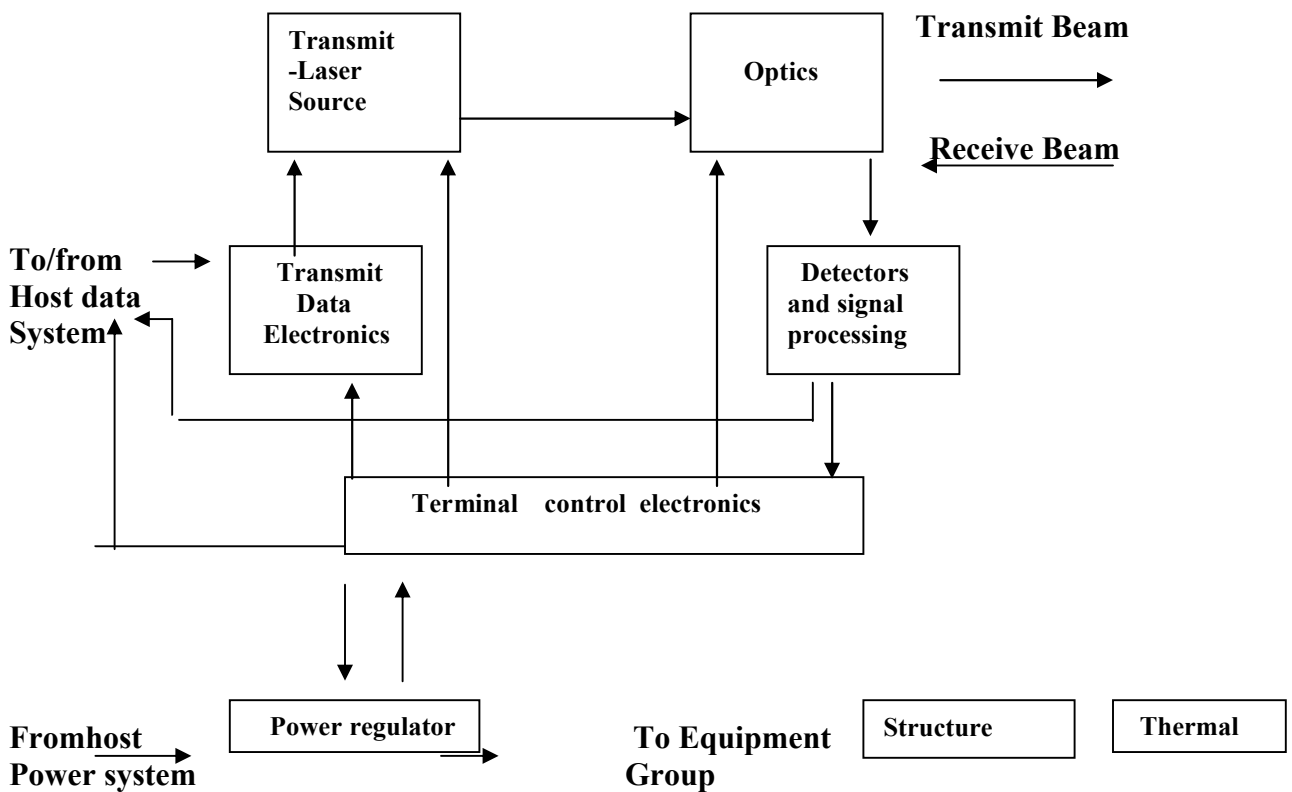

Information typically in the form of digital data is input to data electronics that modulates the transmitting data source. Direct or indirect modulation techniques may be employed depending on the type of laser used. The source output passes through an optical system into the channel. The optical system typically includes transfer, beam shaping and telescope optics. The receiver beam comes in through the optical system and is passed along to the detectors and signal processing electronics. There are also terminal controlled electronics that must control the gimbals and other steering mechanism and servos to keep the acquisition and tracking system operating in the designed modes of operation

5.SYSTEM CHARACTERISTICS AND DESCRIPTION

The key system characteristics which when quantified, together gives a detailed description of a laser communications system. These are identified and quantified for a particular application. The critical parameters are grouped into five major categories: link,transmitter, channel, receiver, and detector parameters.

5.1 LINK PARAMETERS

The link parameters include the type of laser ,wavelength,type of link,and the required signal criterion.today the laserstypically used in free space laser communicationsare the semiconductor laser diodes,solid state lasers,or fiber amplifier lasers.Laser sources are described as operating in either insingle or multiple longitudinal modes. In the single longitudinal mode operationthe laser emits radiation at a single frequency,while in the multiple longitudinal mode ,multiple frequencies are emitted.

Semiconductor lasers have been in development for three decades and have only recently (within the past 7 years) demonstrated the levels of performance needed for the reliable

operation as direct sources. typically operating in the 800-900 nm range (gallium arsenide/gallium aluminium arsenide) their inherently high efficiency (50%) and small size made this technology attractive. the key issues have been the life times, asymmetric beam shapes, output power.

Solid state lasers have offered higher power levels and the ability to operate in high peak power modes for the acquisition. When laser diodes are used to optically pump the lasing media graceful degradation and higher overall reliability is achieved. A variety of materials have been proposed for laser transmitters: neodymium doped yttrium aluminium garnet (Nd:YAG) is the most widely used. Operating at 1064 nm, these lasers require an external modulator leading to a slight increase in the complexity and reliability.

With the rapid development of terrestrial fiber communications, a wide array of components are available for the potential applications in space. These include detectors, lasers, multiplexers, amplifiers, optical pre amplifiers etc. operating at 1550 nm erbium doped fiber amplifiers have been developed for commercial optical fiber communications that offer levels of performance consistent with many free space communications applications.

There are three basic link types: acquisition, tracking and communications. The major differences between the link types are reflected in the required signal criterion for each. For acquisition the criterion are acquisition time, false alarm rate, probability of detection. For the tracking link the key considerations are the amount of error induced in the signal circuitry. This angle error is referred to as the noise effective angle. For the communications link, the required data and the bit error rates are of prime importance.

5.2 TRANSMITTER PARAMETERS

The transmitter parameter consists of certain key laser characteristics, losses incurred in the transmit optical path, transmit antennae gain, transmit pointing losses. The key laser characteristics include peak and average optical power, pulse rate and pulse width. In a

pulsed configuration the peak laser power and duty cycle are specified, whereas in continuous wave application, the average power is specified.

Transmit optical path loss is made up of optical transmission losses and the loss due to the wavefront quality of the transmitting optics. The wavefront error loss is analogous to the surface roughness loss associated with the RF antennas. The optic transmit antenna gain is analogous to the antenna gain in the RF systems and describes the on axis gain relative to an isotropic radiator with the distribution of the transmitted laser radiation defining the transmit antenna gain. The laser sources suitable for the free space communications tend to exhibit a gaussian intensity distribution in the main lobe. The reduction in the far field signal strength due to the transmitter mispointing is the transmitter pointing losses. The pointing error is composed of bias (slowly varying) and random (rapidly varying) components.

5.3 CHANNEL PARAMETERS

The channel parameters for an optical intersatellite link (ISL) consists of range and associated loss, background spectral radiance and spectral irradiance. The range loss is directly proportional to the square of wavelength and inversely proportional to the square of the separation between the platform in metres.

5.4 RECEIVER PARAMETERS

The receiver parameters are the receiver antenna gain, the receive optical path loss, the optical filter bandwidth and the receiver field of view. The receiver antenna gain is proportional to the square of effective receiver diameter in metres and inversely proportional to the square of the wavelength. The receiver optical path loss is simply the optical transmission loss for systems employing the direct detection techniques. However for the lasers employing the coherent optical detection there is an additional loss due to the wavefront error. The preservation of the wavefront quality is essential for the optimal mixing of the received signal and the local oscillator fields on the detector surface.

The optical filter bandwidth specifies the spectral width of the narrow band pass filter employed in optical inter satellite links. Optical filters reduce the amount of unwanted background entering the system. The optical width of the filter must be compatible with the spectral width of the laser source. The minimum width will be determined by the acceptable transmission level of the filter.

The final optical parameter is the angular field of view (FOV), in radians which limits the background power of an extended source incident on the detector. To maximize the rejection, the FOV should be as small as possible. For small angles the power incident on the detector is proportional to FOV squared. The minimum FOV is limited by optical design constraints and the receiver pointing capability.

5.5 DETECTOR PARAMETERS

The detector parameters are the type of detector, gain of detector, quantum efficiency, heterodyne mixing efficiency, noise due to the detector, noise due to the following pre amplifier and angular sensitivity.

For optical ISL systems based on semiconductor laser diodes or Nd:YAG lasers the detector of choice is a p type intrinsic n type (PIN) or an avalanche photodiode (APD)

A PIN photodiode can be operated in the photovoltaic or photoconductive mode and has no internal gain mechanism. An APD is always operated in the photoconductive mode and has an internal gain mechanism, by virtue of avalanche multiplication. The quantum efficiency of the detector is the efficiency with which the detector converts the incident photons to electrons. The mean output current for both the PIN and APD is proportional to the quantum efficiency. By definition the quantum efficiency is always less than unity.

Another detector parameter is the noise due to the detector alone. Typically in a detector there is a DC current even in the absence of signal or background. This DC dark current produces a shot noise current just as the signal and the noise currents do. In an APD there are two contributors to this DC dark current—an multiplied and an unmultiplied current.

The output of the detector is the input to the preamplifier that converts the detector signal current into a voltage and amplifies it to a workable level for further processing. Being the first element past the detector, the noise due to the preamplifier can

have a significant effect on the systems sensitivity. The selection of the pre amplifier design and the internal transistor design and the device material depends on a number of factors.

6 ADVANTAGES OF LASER SYSTEMS

Laser communication systems offer many advantages over radio frequency (RF) systems. Most of the differences between laser communication and RF arise from the very large difference in the wavelengths. RF wavelengths are thousands of times longer than those at optical frequencies are. This high ratio of wavelengths leads to some interesting differences in the two systems. First, the beam-width attainable with the laser communication system is narrower than that of the RF system by the same ratio at the same antenna diameters (the telescope of the laser communication system is frequently referred as an antenna). For a given transmitter power level, the laser beam is brighter at the receiver by the square of this ratio due to the very narrow beam that exits the transmit telescope. Taking advantage of this brighter beam or higher gain, permits the laser communication designer to come up with a system that has a much smaller antenna than the RF system and further, need transmit much less power than the RF system for the same receiver power. However since it is much harder to point, acquisition of the other satellite terminal is more difficult. Some advantages of laser communications over RF are smaller antenna size, lower weight, lower power and minimal integration impact on the satellite. Laser communication is capable of much higher data rates than RF.

The laser beam width can be made as narrow as the diffraction limit of the optic allows. This is given by beam width = 1.22 times the wavelength of light divided by the radius of the output beam aperture. The antennae gain is proportional to the reciprocal of the beam width squared. To achieve the potential diffraction limited beam width a single mode high beam quality laser source is required; together with very high quality optical components throughout the transmitting sub system. The possible antennae gain is

restricted not only by the laser source but also by the any of the optical elements. In order to communicate, adequate power must be received by the detector, to distinguish the signal from the noise. Laser power, transmitter, optical system losses, pointing system imperfections, transmitter and receiver antennae gains, receiver losses, receiver tracking losses are factors in establishing receiver power. The required optical power is determined by data rate, detector sensitivity, modulation format ,noise and detection methods.

7. BEAM ACQUISITION, TRACKING AND POINTING

The use of extremely narrow optical beams for a satellite cross-link introduces obvious beam pointing problems. The transmitting satellite should transmit the narrowest possible beam for maximum power concentration. The minimal band width is limited by the expected error in pointing the beam to the receiver. The pointing error ultimately decides the minimal beam size.

Pointing error is determined by the accuracy to which the transmitting satellite can illuminate the receiving satellite. This depends on the accuracy to which one satellite knows the location of the other, the accuracy with which it knows its own orientation in space and the accuracy to which it can aim its beam, knowing the required direction. Satellite beam pointing by ground control will not permit the micro radiant beam width projected for the optical link. Determination of the satellite location can be aided by using an optical beacon transmitted from the receiving antennae back to the transmitting satellite. The transmitting satellite receives the beacon then transmits the modulated laser beam back towards the beacon direction of arrival. The uncertainty in absolute satellite location is transferred to smaller uncertainty in reading beacon arrival direction. The beacon must be trapped in time to provide updated position information.

When the beams are extremely narrow there is a possibility that the receiving satellite may have moved out of transmitters beam width during the round trip transmission time. The transmitting satellite should point ahead from its measured beacon arrival direction.

$$\alpha = V_t / 150 \text{ } \mu \text{ radians}$$

where α is the point ahead required and

V_t is the tangential velocity of the satellite in m\.

If this exceeds one half the beam width the point ahead must be used. This means that the transmitting laser cannot transmit back through the same optics from which the beacon is received. It is independent of the satellite cross link distance.

The use of a beacon modifies the optical hardware on each satellite, since the transmitting and receiving satellite must contain both a transmitting laser and a optical receiver. This means either satellite can serve as a transmitter and an optical data can be sent in both directions. The modulated laser beam can serve as a beacon for the return direction. The receiving optics tracks the arrival beam direction and adjusts the transmitting beam direction. Separate wavelengths are used for optical beams in each direction. If no point ahead is needed, the transmit and receive optics can be gimballed together and the laser transmits through receive optics. If point ahead is needed then command control (either stored or received from the earth station) must adjust transmitting direction relative to receiving direction.

In establishing an optical cross link we require the initial acquisition and tracking of the beacon by the transmitting satellite followed by a pointing of a laser beam after which the data can be modulated and transmitted.

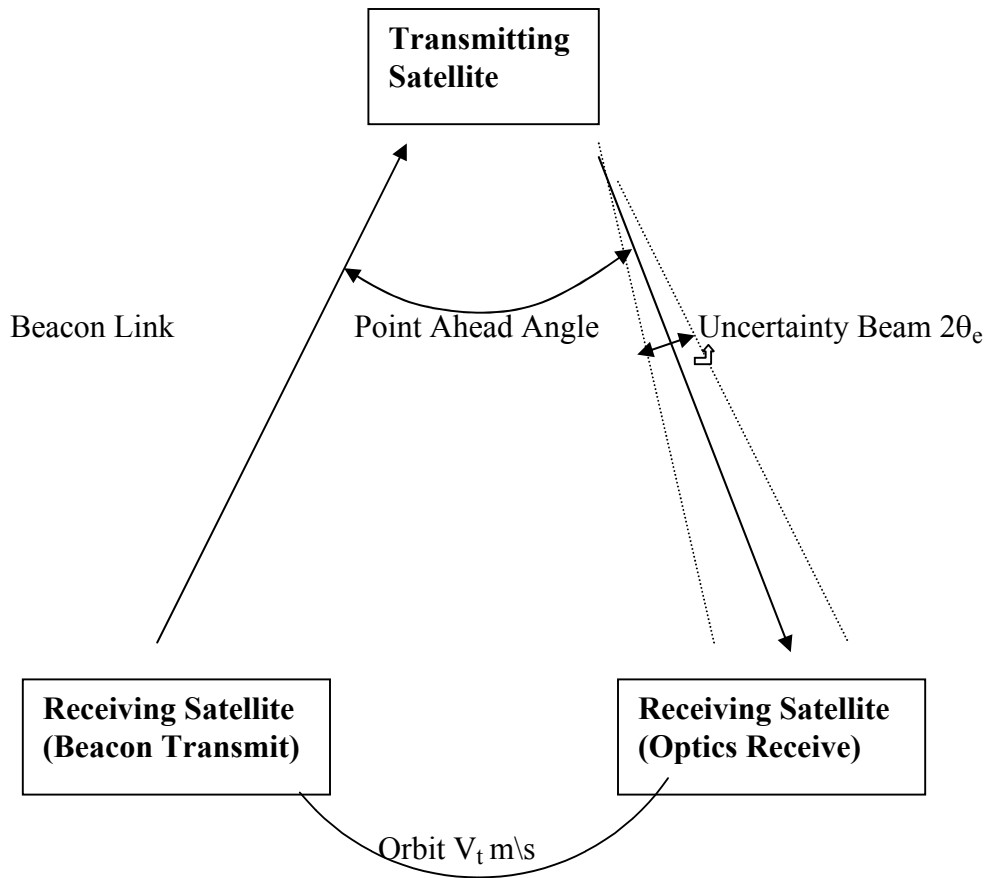

Required beam widths and point ahead model for optical pointing

7.1 TRACKING MODES FOR SATELLITE SUBSYSTEMS

Several approaches to tracking have been used in laser communications. Free space laser inter-satellite links require terminal pointing, acquisition, and tracking subsystems that are capable of high speed, high accuracy pointing control for acquisition and tracking to support communication operations. Without the ability to return a beam along the line of sight towards the companion terminal, communications cannot take place. By employing a simple chopper wheel in the optical receiver path, a quadrant avalanche photodiode can be made to track a known stellar object. The difficulty in system design revolves around the limited view field and narrow wavelength bands typical of laser cross-link receivers. A typical laser communication pointing and tracking system is nested with a gimbal and fine tracking loop plus the additional forward correction offered by a point-ahead loop. Low-bandwidth disturbances are normally added linearly, while higher frequency disturbances are root-sum squared to achieve an estimate of the pointing uncertainty. The total pointing error is the contribution of the bias and the random term's. Tracking systems can be divided in two distinct categories. The first category involves those systems that derive the track information from communication signals. The second technique set concerns those systems that use a separate laser beacon to track. The first technique to track signals is dc tracking. The term is used to describe tracking the laser source by integrating the received amplitude-modulated signal over a large number of cycles or pulses. Commonly, an integrating type of detector such as CCD, which will be optimized to the track bandwidth, would be used to track the beam. With dc tracking, the drawback is the susceptibility to optical background, especially point sources in the field of view (FOV). DC tracking is not recommended because unique discrimination is not possible without very narrow linewidth filtering of the signal. A second technique for tracking a communication signal is pulse tracking. This technique is used when the communication source is also a pulse waveform but can be used also as an independent beacon channel. With pulse tracking system, each pulse is detected with the receiver threshold and uses this information to generate a high-bandwidth tracking error signal from the track quadrants. Pulse tracking has a high-bandwidth receiver front end to

effectively detect very short pulses. In the dc system, the bandwidth is dependent upon the communication system, pulse width and pulse rate .

Another technique of tracking systems that derives a track signal by squaring the communication waveform to generate a tracking signal, is Square-Law Tracking. This technique can be used most effectively when a single quasi-CW modulated source is used for communication. Squaring the incident signal waveform at twice the signal bandwidth generates a harmonic signal. This harmonic signal can then be phase-locked and used to generate the quadrant track errors. One inconvenience with this technique is that the track signal is twice the communication bandwidth and the tracking system is more dependent upon the data rate.

Figure below shows this type of tracking system.

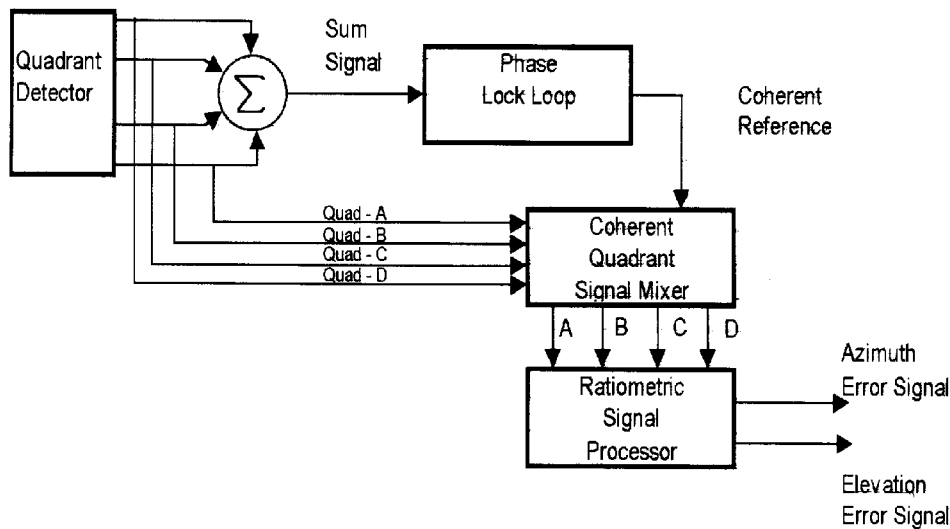

Tone tracking involves transmitting a separate tone beacon via an additional laser source or modulating the tone into the communication waveform. In this type of modulated tone, the frequency does not interfere with the message content of the communication waveform. If a wavelength separation is available it could involve a separate detector.

By using coherent waveform techniques, spatial inter satellite tracking can be achieved. Coherent techniques use the high front-end local-oscillator gain to compensate for downstream noises. There are others approaches to track a system using Non conventional Tracking Techniques like Gimbal-Only Tracking and Feed-Forward Tracking.

7.2 SPATIAL INTER SATELLITE TRACKING

The use of optical frequency for communications has several advantages such as high, bandwidth, lower power requirements, and smaller antenna size, minimization of spurious background, privacy, and jam-resistance. The selection of beamwidth and field-of view is not inhibited by aperture size, wavelength, and surface quality, but by the ability of the communication terminal to acquire, point, and track to a compatible accuracy.

9.CONCLUSION

The implementation of any of these systems in an inter-satellite link will require a substantial development effort. The strengths and weaknesses of the various types of lasers presently available for laser communications should be carefully considered. Based on existing laser's characteristics, the GaAlAs system, especially the full-bandwidth, direct detection system is the most attractive for inter satellite links because of its inherent simplicity and the expected high level of technological development. The system and component technology necessary for successful inter satellite link exists today. The growing requirements for the efficient and secure communications has led to an increased interest in the operational deployment of laser cross-links for commercial and military satellite systems in both low earth and geo-synchronous orbits. With the dramatic increase in the data handling requirements for satellite communication services, laser inter satellite links offer an attractive alternative to RF with virtually unlimited potential and an unregulated spectrum.